

RICHMOND

GATE HARDWARE

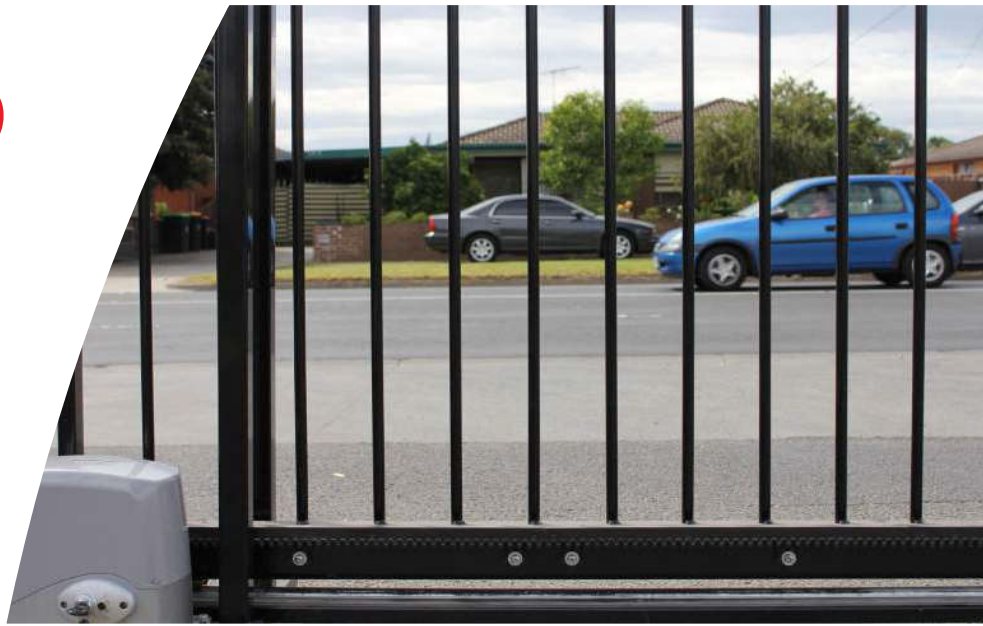
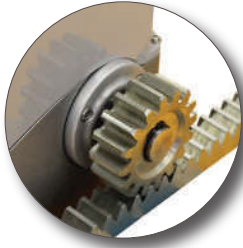

Bearings &
Power Transmission Pty Ltd
Phone 07 4636 0522

Bearings & Power Transmission Pty Ltd
(Phone) 07 4636 0522
Email: sales@bpt.net.au
(website) www.bpt.net.au

GATER

by Richmond

Sliding Gate Hardware
Swing Gate Hardware
Cantilever Gate Hardware

DOUBLE BEARING Track Wheel & Bolt



All Richmond Track Wheels are fitted with quality bearings and the double bearing design allows for an increased load capacity. The CNC machined, precision C groove ensures a smooth and consistent rolling action on the gate track and the gold zinc plating provides rust protection. For track to suit, see GTR010.

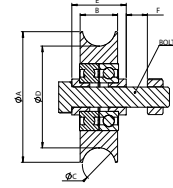

Model Number	A	D	B	C	E	F	Bolt	Capacity
GTR006	78mm	61mm	23mm	20.5mm	33mm	1-10mm	M10 x 60mm	250kg
GTR007	88mm	71mm	24mm	20.5mm	33mm	1-20mm	M14 x 70mm	250kg
GTR008	98mm	81mm	24mm	20.5mm	33mm	1-20mm	M14 x 70mm	400kg
GTR009	118mm	101mm	30mm	20.5mm	39mm	1-15mm	M14 x 70mm	500kg

BOTTOM MOUNT Track Wheel



- Bolts flat to the bottom of the gate.
- C Groove profile to suit GTR010 gate track.
- Gold zinc plated wheel and housing.
- Double bearings.

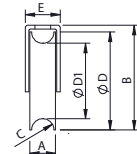
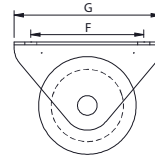

Model Number	A	B	C	D	D1	E	F	G	Capacity
GTR001	23mm	85mm	20.5mm	78mm	60mm	35mm	70mm	100mm	250kg
GTR002	30mm	127mm	20.5mm	118mm	100mm	42mm	130mm	158mm	400kg

Recessed Track Wheel



- Mounts recessed into the bottom of the gate for a low gate profile.
- C Groove profile to suit GTR010 gate track.
- Gold zinc plated wheel and housing.
- Double bearings.

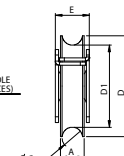
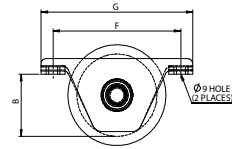

Model Number	A	B	C	D	D1	E	F	G	Capacity
GTR003	23mm	41mm	20.5mm	78mm	60mm	32mm	110mm	135mm	250kg
GTR004	24mm	55.5mm	20.5mm	88mm	70mm	34mm	128mm	152mm	250kg
GTR005	24mm	60.5mm	20.5mm	98mm	80mm	34mm	128mm	152mm	300kg

Bolt Down Sliding Gate Track

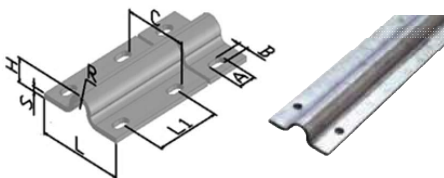

Galvanized sliding gate track to suit the track wheels above.

Model Number	Track Length	L	L1	H	S	A	B	C	R
GTR010	3 meters	55mm	300mm	15mm	3.5mm	11mm	6mm	40mm	R13.5mm

IN-GROUND Sliding Gate Track

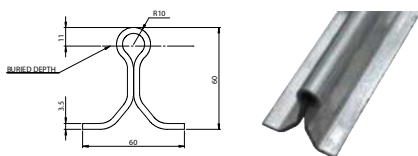

Galvanized, concrete-in sliding gate track to suit the track wheels above.

Model Number	Track Length	L	L1	H	S	A	B	C	R
GTR046	5.8m	55mm	300mm	15mm	3.5mm	11mm	6mm	40mm	R13.5mm

90° SINGLE Roller Guide

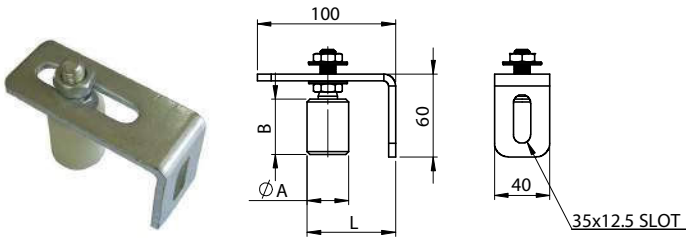

These 90° adjustable guides are designed to be bolted to a wall, post or pillar. The heavy gauge steel (5mm) ensures a strong support with high resistance to flexing. The brackets are supplied with a low wear, low friction, solid nylon roller and are slotted for adjustment.

Model Number	A	B	L	Bolt	Capacity
GTR014	30mm	40mm	46-94mm	M12	50kg

90° Double Roller Guide

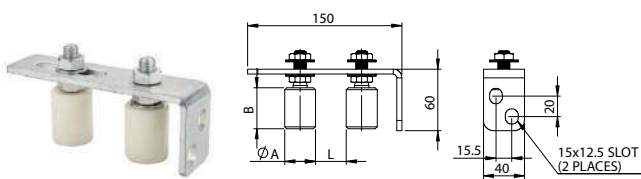

Suitable for gates from 8mm to 55mm wide, these adjustable double roller gate guides ensure a smooth and straight movement of sliding gates. Rollers can be mounted in either side of the slot depending on your needs. The brackets are supplied with dual low wear, low friction, solid nylon rollers.

Model Number	A	B	L	Bolt	Capacity
GTR015	30mm	40mm	8-55mm	M12	50kg

Bend To Suit Double Roller Guide

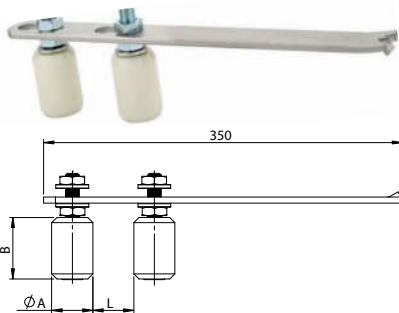

These rollers guides are designed to be drilled and bent to suit the installation. The wide adjustment suits gates from 15mm to 65mm wide. Rollers can be mounted in either side of the slot depending on your needs. The brackets are fitted with 2 low wear, low friction, solid nylon rollers.

Model Number	A	B	L	Bolt	Capacity
GTR016	40mm	60mm	15-65mm	M14	50kg

Bend To Suit Double Roller Guide (Bracket Only)

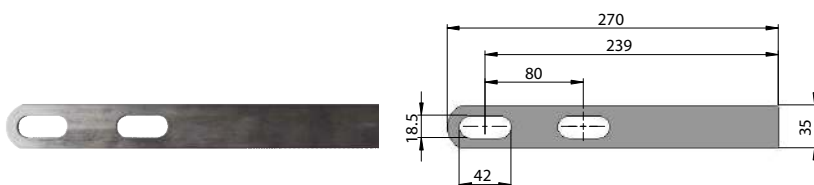

Bend to suit roller guide bracket without rollers.

Model Number	Thickness
GTR048	6mm

Nylon Roller

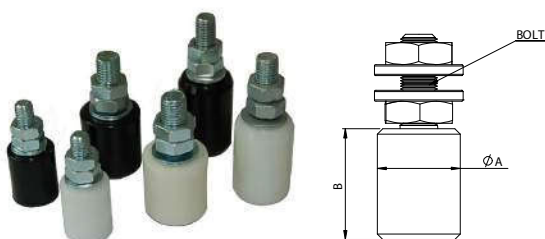

Our low friction, low wear, nylon rollers are supplied on bolts with locking nuts. Inferior quality gate rollers can become brittle and discoloured over time. Our rollers are manufactured from UV resistant nylon to prevent this kind of degradation.

Model Number	A	B	Bolt	Capacity
GTR011	30mm	40mm	M12	40kg
GTR012	40mm	60mm	M14	50kg
GTR013	40mm	150mm	M16	50kg

Gate Stopper

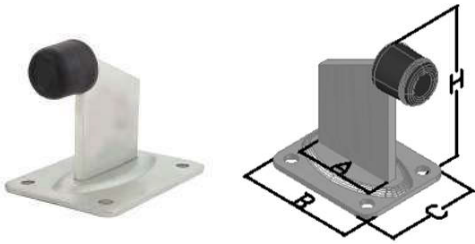

Gate stopper with bolt down base to prevent your swing or sliding gate from opening too far. Features a silver zinc plated steel frame and a durable rubber stopper.

Model Number	A	H	B	C
GTR017	50mm	95mm	100mm	80mm
GTR018	70mm	110mm	130mm	90mm

Steel Gear Rack



Silver zinc plated Gear rack to suit Module 4 (M4) drive pinions. Supplied in 1 meter lengths.

Model Number	Length	Width	Height	Rack Pitch
GTR039	1 meter	22mm	22mm	Module 4

Nylon Gear Rack



Durable Nylon Gear rack to suit Module 4 (M4) drive pinions. Supplied in 1 meter lengths.

Model Number	Material	Length	Width	Height	Rack Pitch
GTR020	Nylon	1 meter	20mm	26mm	Module 4

Gate End Stop



Gate end stopper with gold zinc plated steel frame and rubber stopper. Features angled tabs to guide the gate into the stopper.

Model Number	Opening Width	Stopper Type	Steel Finish
GTR019	Max 80mm	Rubber	Zinc Plated

Gate post cap



Don't allow your gate post to fill with rain and corrode. Cap them off with these gold zinc plated post caps. 2 sizes available to suit common SHS dimensions. Mounting holes to suit countersunk self tapping screws.

Model Number	Suit Post Size	Steel Finish
GTR021	40mm x 40mm	Zinc Plated
GTR022	50mm x 50mm	Zinc Plated

Cantilever Gate Channel

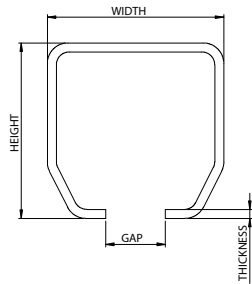

Supplied in 5.8 meter lengths, our galvanised gate channel comes in 3 different sizes.

Cantilever gate designs are frequently used as no track work needs to be installed. This makes cantilever gates an option for surfaces that are inappropriate for track gates.

Model Number	Height	Width	Gap	Thickness	Length	Max Gate Opening	Max Gate Weight
GTR023	68mm	68mm	23mm	3.5mm	5.8 meters	5 meters*	600kg*
GTR024	89mm	100mm	33mm	5mm	5.8 meters	7 meters*	1000kg*
GTR025	140mm	140mm	38mm	6mm	5.8 meters	14 meters*	2000kg*

*Maximum capacity for standard installs. Our Engineering Department can offer advice on safely exceeding these values.

Cantilever Gate 5 Wheel SET

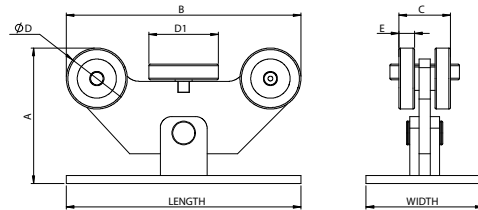

The fifth support wheel makes this carriage ideal for cantilever gates with some wind loading. Features high quality wheels and a strong steel frame.

Model Number	A	B	C	D	D1	E	Length	Width	Capacity	Channel To Suit
GTR026	136mm	196mm	47.5mm	60mm	60mm	15mm	180mm	150mm	300kg	GTR023
GTR027	173mm	300mm	66mm	78mm	89mm	20mm	300mm	150mm	500kg	GTR024
GTR028	246mm	469mm	97mm	126mm	126mm	30mm	500mm	200mm	1000kg	GTR025

Cantilever Gate GUIDE Wheel

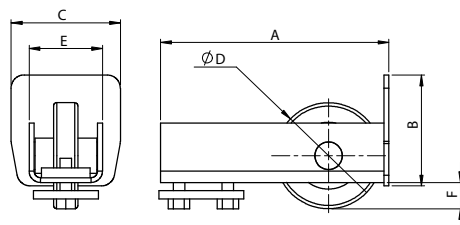

These guide wheels are clamped in the ends of the gate channel. The wheel will protrude from the bottom of the channel and will roll smoothly into the "End Catch" (Sold Separately).

Model Number	A	B	C	D	E	F	Channel To Suit
GTR029	140mm	68mm	67mm	65mm	45mm	16mm	GTR023
GTR030	144mm	89mm	100mm	75mm	63mm	15mm	GTR024
GTR031	195mm	140mm	140mm	98mm	95mm	24mm	GTR025

Cantilever Gate END CATCH

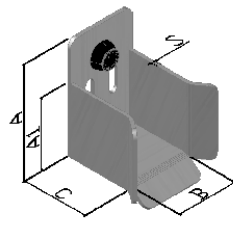

Designed to work with our "Gate Guide Wheels", these end catches are zinc plated to protect from rust and feature angled tabs to guide the gate into the rubber stopper.

Model Number	A	A1	B	C	S	Channel To Suit
GTR033	130mm	80mm	82mm	74mm	4mm	GTR023
GTR032	168mm	102mm	108mm	79mm	4mm	GTR024
GTR047	222mm	154mm	145mm	83mm	4mm	GTR025

Cantilever CHANNEL END CAP

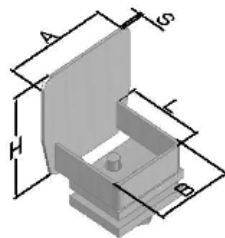

Used to cap off the back of your gate channel, these end caps are zinc plated and mounted with a strong clamp system to avoid welding.

Model Number	A	H	B	L	S	Channel To Suit
GTR034	68mm	68mm	52mm	57mm	3mm	GTR023
GTR035	100mm	89mm	52mm	57mm	3mm	GTR024
GTR036	140mm	140mm	95mm	86mm	3mm	GTR025

Nylon Roller Set and Bracket

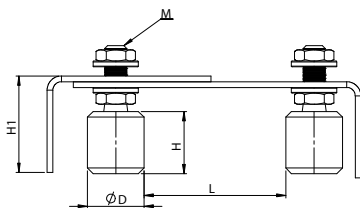

Set of 4 solid Nylon rollers in an adjustable steel frame to suit gates from 60mm to 103mm wide.

Using quality industrial nylon roller guides will help keep your gate running smoothly. Richmond rollers are manufactured from UV resistant Nylon to prevent the rollers becoming brittle and discoloured over time.

Model Number	D	H	A	H1	L	M	Capacity
GTR038	40mm	44mm	290mm	68mm	60mm-103mm	M16	50kg

Nylon Roller with Bracket

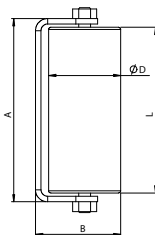

Heavy duty nylon roller assembly with mounting bracket and high quality bearings for increased load capacity. Richmond rollers are manufactured from UV resistant Nylon to prevent the rollers becoming brittle and discoloured over time.

Model Number	A	B	D	L	Capacity
GTR037	168mm	78mm	66mm	152mm	50kg

Hanging Gate Channel

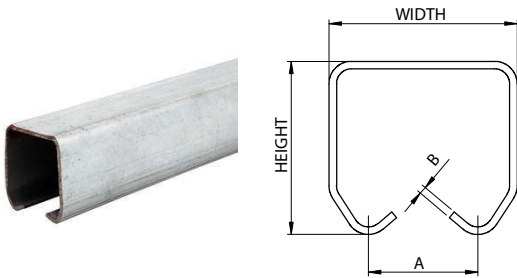

Galvanised channel to suit the GTR044 roller set and brackets below. Roof or wall mount, our hanging gate channel is durable and easy to install.

Model Number	Height	Width	A	B	Capacity	Length
GTR040	46mm	50mm	29mm	2mm	200kg	5.8m

HANGING GATE 4 wheel ROLLER SET

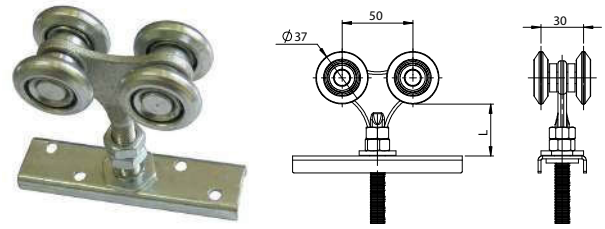
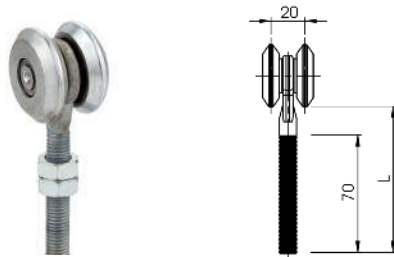

Plate mount 4 wheel roller set to suit the GTR040 Hanging Gate Channel. Featuring silver zinc plating and high quality wheels.

Model Number	Wheel Diameter	L	Thread	Channel To Suit	Capacity
GTR044	37mm	40-82mm	M12	GTR040	100kg

HANGING GATE 2 wheel ROLLER SET



M12 thread mount wheel set featuring 2 high quality wheels for smooth operation and zinc plating.

Model Number	Wheel Diameter	L	Thread	Capacity
GTR043	44mm	87mm	M12	50kg

HANGING GATE 4 wheel ROLLER SET

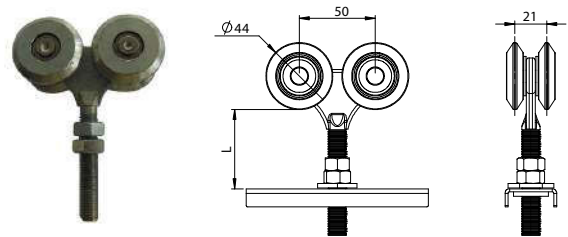

M12 thread mount wheel set featuring 4 high quality wheels and zinc plating.

Model Number	Wheel Diameter	L	Thread	Capacity
GTR045	44mm	34-78mm	M12	100kg

Hanging Gate CHANNEL Bracket (Roof Mount)

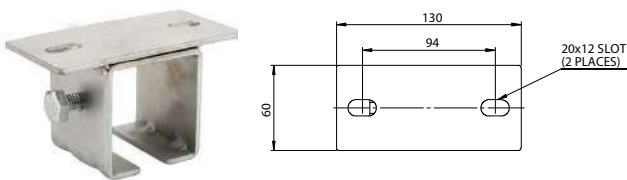

Strong and durable, yet low profile roof mount bracket to suit GTR040 Hanging Gate Channel.

Model Number	Suit Channel
GTR041	GTR040

Hanging Gate Channel Bracket (Wall Mount)

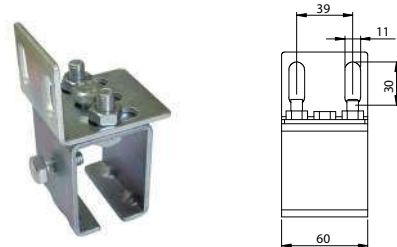

These wall mount brackets are adjustable to vary the distance from the wall and suit GTR040 Hanging Gate Channel.

Model Number	Suit Channel
GTR042	GTR040

AC Sliding Gate Kit



Kit Contents:
 1 x AC or DC Motor
 2 x Remote Controls
 4 x 1m Gear Rack
 Instruction manual
 Brackets, fittings & hardware

Hardwiring 240VAC requires installation by a qualified electrician.



- Suitable for gates up to 600kg
- Manual release back-up
- 50m range remote controls
- Adjustable automatic closing
- Gate moving speed 13m/min
- Water/dust resistant to IP44
- 1 year manufacturer's warranty
- Adjustable time and force settings

Model Number

Max Weight Capacity

Supply Voltage

GTR060

600kg

240AC / 24DC



THIS KIT IS SOLAR READY.



ADD THESE ACCESSORIES FOR SOLAR OPERATION

24V SOLAR PANEL

				
Part Number	Rated Voltage	Maximum Power	Operating Voltage	Module Size (mm)
GTR049	24V	30W	35.5V ±0.5	670 x 440 x 28

24V/10A Solar Charge Controller

			
Model Number	Rated Voltage	Max Input Current	Max Load Current
GTR050	24V	10 Amp	10 Amp

Batteries

		
Part Number	Voltage	
GTR061	12V / 7AH	2 pieces required

Battery box

Part Number
GTR059

AC SWING Gate Kit



Hardwiring 240VAC requires installation by a qualified electrician.

- Suitable for swing gates with arms up to 300kg and 3m long.
- High quality stainless steel swing arm
- Manual release back-up
- 50m range remote controls

- Adjustable time and force settings
- Adjustable automatic closing
- Water/dust resistant to IP44
- Opening time 8 - 12 seconds

Kit Contents:
 2 x Gate Swing Arms
 1 x Control Box
 2 x Remote Controls
 Instruction manual
 Brackets, fittings & hardware

Model Number

Max Weight Capacity

Supply Voltage

GTR058

600kg

240VAC



THIS KIT IS SOLAR READY.



ADD THESE ACCESSORIES FOR SOLAR OPERATION

24V SOLAR PANEL

				
Part Number	Rated Voltage	Maximum Power	Operating Voltage	Module Size (mm)
GTR049	24V	30W	35.5V ±0.5	670 x 440 x 28

24V/10A Solar Charge Controller

			
Model Number	Rated Voltage	Max Input Current	Max Load Current
GTR050	24V	10 Amp	10 Amp

Batteries

		
Part Number	Voltage	
GTR061	12V / 7AH	2 pieces required

Battery box

Part Number
GTR059

Wired Access Control Keypad



GTR055 programmable wired access control keypad in metal enclosure with backlit keypad.

Keypad Model Number

GTR055



Supply Voltage

12V or 24V



GTR056 optional gooseneck mounting post to suit the keypad. Post is designed to be cemented in place.

Optional Gooseneck Post

GTR056

Infrared Photocells



Infrared photocell pair to prevent gates closing on vehicles/pedestrians.

*Max Range may be reduced in bad weather conditions.

Model Number	Max Range*	Supply Voltage	Max Relay Output	Alignment Tolerance
GTR051	20 meters	12-24V	1A (30V)	±10°

Remote Control



Long range remote control to suit Richmond gate kits.

Model Number

GTR054

Spring Loaded Gate Castors

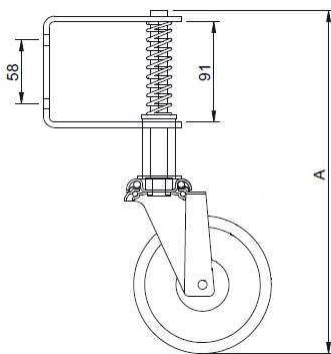

S5022

S5024

Richmond's Spring Loaded Gate Castors are designed to make opening and closing of residential gates smoother and easier. The spring loaded design provides shock absorption on uneven surfaces. All gate castors can swivel 360 degrees for easy maneuverability.

Model Number	Wheel Type	Wheel Diameter	Height (A)	Spring Capacity	Castor Capacity
S3022	Rebound Rubber	75mm	259mm	20kg	80kg
S3024	Nylon	75mm	259mm	20kg	80kg
S4022	Rebound Rubber	100mm	285mm	20kg	100kg
S4024	Nylon	100mm	285mm	20kg	100kg
S5022	Rebound Rubber	125mm	311mm	20kg	100kg
S5024	Nylon	125mm	311mm	20kg	100kg

Also Available From Richmond

Wheels & Castors

Richmond stock a range of high quality wheels and castors to suit any application. The range spans from furniture castors through to wheels with a 5 tonne capacity.



Contact us for a copy of our Wheels and Castors Catalogue

RICHMOND
WHEELS & CASTORS

Hand Trolleys

Richmond's versatile line of hand trolleys range from lightweight aluminium folding trolleys through to heavy duty, professional trolleys with a load capacity of up to 300kg.



View the full range online or in our Material Handling Catalogue

RICHMOND
MATERIAL HANDLING

WheelBarrows

From lightweight plastic tray barrows, through to heavy duty steel barrows rated to 200kg. No matter the application, you will find a Richmond wheelbarrow to suit your needs.



Contact us for a copy of our Material Handling Catalogue

RICHMOND
MATERIAL HANDLING

Pipe Rollers

Richmond are the industry leader in designing and manufacturing heavy duty roller products for industry. We can manufacture to suit any application.



Visit www.richmondpiperollers.com.au for more information on Pipe Rollers

RICHMOND
PIPE ROLLERS

Service Trolleys

Our Service Trolleys are highly durable, versatile and able to perform a tasks in a variety of environments. All models are supplied standard with non marking wheels and large lipped shelves to hold various equipment and supplies.



Contact us for a copy of our Material Handling Catalogue

RICHMOND
MATERIAL HANDLING

SITE SAFETY EQUIPMENT

Richmond can help you meet your workplace safety obligations by providing a wide range of site safety equipment. Richmond stock bollards, barriers, convex mirrors, spill kits, warning lights and many more items.



Contact us for a copy of our Site Safety Catalogue

RICHMOND
SITE SAFETY